

# SERVICE MANUAL

## 25 FRAME PLUNGER PUMPS

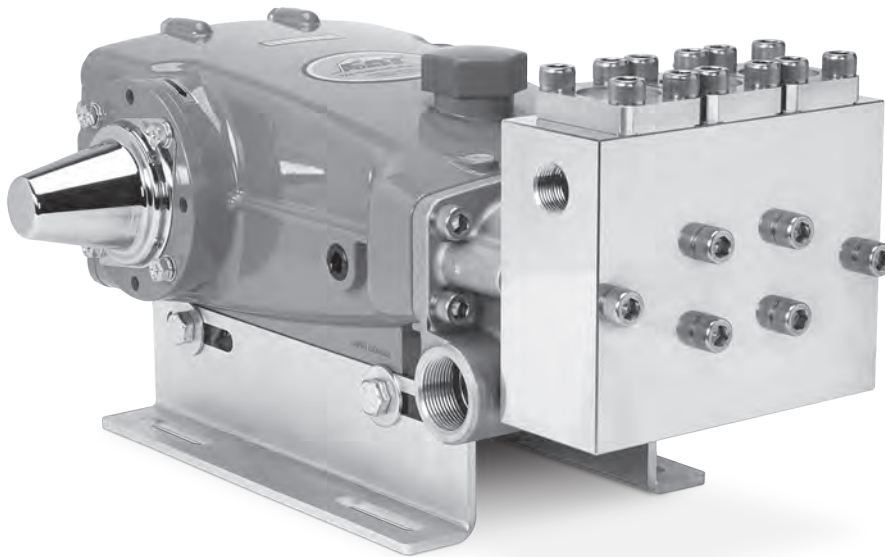

### PUMP MODELS INCLUDED

2560	2565	2560BH	2565BH	
------	------	--------	--------	--

Product Quality, Reliability and Support You Expect

[www.catpumps.com](http://www.catpumps.com)

# Table of Contents

<b>Safety Symbols</b>	2
<b>General Safety Information</b>	3
<b>Seal &amp; Valve Kits</b>	6
Service Intervals	6
<b>Seal &amp; Valve Kit Pump Diagram</b>	7
<b>Tools Needed</b>	7
<b>Servicing the Seals</b>	8
Manifold and Seal Removal	8
Plunger Removal	11
Plunger Reassembly	12
Seal Installation	13
Manifold Reassembly	14
<b>Servicing the Valves</b>	15
Valve Removal	15
Valve Disassembly	16
Valve Reassembly	18
Valve Installation	20
<b>Crankcase Component Inspection</b>	21
<b>Reference Information</b>	22
Preventive Maintenance Schedule	22
Torque Chart	23
Discharge Manifold Torque Sequence	23
Valve Plug Cover Torque Sequence	23
Technical Bulletin Reference Chart	23
<b>Diagnosis and Maintenance</b>	24

## Safety Symbols

### IMPORTANT SAFETY INSTRUCTIONS

It is the responsibility of the user to read and understand all instructions, important safeguards and safety precautions before operating or servicing any pump. Failure to do so may result in property damage, personal injury or death.

### GENERAL SAFETY INFORMATION AND SYMBOLS

Pay special attention to the following signal words, safety alert symbols and statements:



**DANGER**

Indicates a hazardous situation which, if not avoided, will result in death or serious injury.



**WARNING**

Indicates a hazardous situation which, if not avoided, could result in death or serious injury.



**CAUTION**

Indicates a hazardous situation which, if not avoided, could result in minor or moderate injury or property damage.



**NOTICE**

Indicates a hazardous situation which, if not avoided, could result in property damage.



Indicates a potential personal injury hazard. Obey all safety messages that follow this symbol to avoid possible injury or death.

# General Safety Information

## **⚠ DANGER**

### **A. FLAMMABLE OR EXPLOSIVE LIQUID HAZARD**

Do not operate pump with flammable or explosive liquids unless extraordinary safety precautions are observed. Leaks of flammable or explosive liquids, if exposed to elevated temperatures, static electricity, sparks or other hazards, will result in flame or possible explosion, causing serious personal injury, death or property damage.

1. Before operating pump with flammable or explosive liquids, ensure proper maintenance has been performed.
  2. Do not operate pump with flammable or explosive liquids if leaks are detected.
  3. Only pump flammable or explosive liquids that are compatible with pump component materials.
  4. Do not operate pump with flammable or explosive liquids without safeguards or safety systems to detect leaks, elevated temperatures, spark prevention or any other hazards defined by the NFPA systems.
  5. Do not remove Flammable Liquids Product Suitability Hang Tag to assure proper safety.
  6. Follow ATEX guidelines for potentially-explosive atmospheres.
- 

## **⚠ WARNING**

### **A. ELECTRICAL SHOCK HAZARD**

Do not service pump or electrical equipment while energized. Electricity can cause personal injury, death or property damage.

1. Adhere to "Lock Out" and "Tag Out" procedures for electrical equipment.
2. Before commencing pump service, turn power supply off.
3. Keep water away from electrical outlets and electrical devices.
4. Electrical components must be installed by a qualified electrician to avoid risk of electrocution.

### **B. ROTATING PARTS HAZARD**

Do not service pump while energized. Moving, rotating or reciprocating parts can crush and cut, causing personal injury, death or property damage.

1. Adhere to "Lock Out" and "Tag Out" procedures for electrical equipment.
2. Before commencing pump service, turn power supply off, turn water supply off, squeeze trigger on gun to relieve system pressure.
3. For mobile equipment, be sure engines and hydraulics are turned off and secured to avoid accidental start.
4. Do not operate with safety guards removed.
5. Always use safety guards on all belt drives, couplings and shafts.

### **C. HOT SURFACE HAZARD**

Do not touch pump, accessories or drive system while operating and until cool down is complete. Touching hot surface areas of the pump, accessories or drive system can cause severe burns or personal injury.

### **D. SKIN PUNCTURE HAZARD**

Do not allow spray to contact any part of the body or animals. Pumped liquids under high pressure can pierce skin and underlying tissue or can deflect debris leading to serious personal injury or death.

1. Relieve all line pressure in the inlet line to the pump and discharge line from the pump before performing any maintenance on the pump.
2. When a high-pressure gun is not in use, set safety trigger lock (safety latch) to avoid accidental high-pressure operation and personal injury or property damage.
3. Do not check for leaks with hand. Use a piece of cardboard to check for leaks.
4. Review cleaning procedures to minimize heavy back blasting.
5. Wear adequate safety equipment and clothing when operating a high-pressure sprayer. Never use high-pressure spray with bare feet or exposed skin, and always wear safety glasses.

### **E. PUMPING LIQUIDS HAZARD**

Do not operate pump with hot water, chemicals or other hazardous liquids unless extraordinary safety precautions are observed. Pumping hot water, chemicals or other hazardous liquids can expose personnel to serious injury.

1. Provide guards or shields around equipment to protect personnel.
2. Wear mask, goggles or eye protection while operating high-pressure equipment.
3. Obtain a Safety Data Sheet (SDS) and take appropriate safety measures for the liquid being handled.

# General Safety Information and Symbols

## F. OVER PRESSURIZATION HAZARD **WARNING** CONTINUED

Do not operate high-pressure pumping system unless extraordinary safety precautions are observed. A high-pressure pumping system can deadhead or over pressurize causing serious personal injury and property damage.

1. All high-pressure systems require a primary pressure regulating device (e.g., regulator or unloader) and a secondary pressure safety relief device (e.g., pop-off valve, safety valve, rupture disc) to assure proper pressure setting and overpressure protection.
2. All high-pressure systems require a pressure gauge to monitor pressure settings and avoid overpressure of equipment or personal harm.
3. Install primary pressure relief device on the discharge side of the pump.
4. Install secondary pressure relief device between the primary device and pump.
5. Install pressure gauge onto the discharge manifold or in the discharge line near the manifold.
6. Open all valves on discharge side of plumbing before operation.

## G. OXYGEN HAZARD

Do not charge pulsation dampeners with oxygen. Oxygen may cause an explosion causing personal injury, death or property damage.

1. Use nitrogen only when charging pulsation dampeners, **DO NOT USE OXYGEN**.
2. Use proper charging tools to charge pulsation dampeners.
3. Charge pulsation dampener within specifications stated on data sheet to assure proper pulsation dampening and prevent failure of bladder.

## H. FALL HAZARD

Do not operate pressure washer while standing on slippery or unstable surface unless extraordinary safety precautions are observed. Pressure washing may create slippery surface on which a person may slip and fall causing personal injury or death.

1. Wear suitable footwear to maintain a good grip on wet surfaces.
2. Do not stand on ladders or scaffolding.
3. Do not over reach or stand on unstable supports.
4. Keep good footing and balance and hold gun with both hands to control kick back.

---

## **CAUTION**

### A. IMPROPER USE OF FITTINGS HAZARD

Do not operate the pump with improperly-connected, sized, worn or loose fittings, pipes or hoses. Operating the pump under these conditions could result in personal injury and property damage.

1. Ensure all fittings, pipes and hoses are properly rated for the maximum pressure rating and flow of the pump.
2. Check all fittings and pipes for cracks or damaged threads.
3. Check all hoses for cuts, wear, leaks, kinks or collapse before each use.
4. Ensure all connections are tight and secure.
5. Use PTFE thread tape or pipe thread sealant (sparingly) to reconnect plumbing. Do not wrap tape beyond the last thread, this will prevent loose tape from becoming lodged in the pump or accessories.
6. Apply proper sealants to assure secure fit or easy disassembly when servicing.

### B. FROZEN LIQUID HAZARD

Do not operate the pump with frozen liquid. Operating the pump under this condition could over pressurize and jettison the manifold from the crankcase causing personal injury and property damage.

1. Store pump or pumping system in an environmentally-controlled room protected from freezing temperatures.
2. Follow procedures in *TECH BULLETIN 083* to winterize pump.

### C. CLEANING PUMP HAZARD

Do not use solvents that are flammable and toxic to clean or degrease equipment. Use of these solvents could result in personal injury and property damage.

1. Follow safety instructions as found in SDS or on packaging of each liquid.
2. Clean equipment in a well-ventilated area.
3. Disposal of solvents to be in accordance with local, state and federal regulations.

### D. OPERATING BEYOND SPECIFICATIONS HAZARD

Do not operate the pump outside the specifications of individual pump data sheet or service manual. Operating the pump under these conditions could result in personal injury and property damage.

1. Do not operate the pump faster than the maximum recommended RPM.
2. Do not operate the pump at pressures higher than the maximum recommended pressure.
3. Do not operate the pump at temperatures higher than the maximum recommended temperatures.
4. Do not use accessories that are not compatible or rated for the pump.

# General Safety Information and Symbols

## E. LIFTING DEVICE HAZARD CONTINUED

Do not lift pump with unsuitable lifting devices. Use of unsuitable lifting devices may cause pump to fall, resulting in personal injury, damage to pump and/or pump with drive/base plate.

1. Lifting eyes installed on the pump must be used only to lift the pump.
2. Special lifting eyes should be installed on the base for lifting the pumping system (e.g. base, drive and accessories)
3. If slings or chains are used for lifting, they must be safely and securely attached to properly balance the weight of the unit.
4. Inspect slings and chains prior to use and replace worn and damaged slings and chains.

## NOTICE

### A. OIL HAZARD

Use only genuine Cat Pumps custom-blend, premium-grade, petroleum-based hydraulic oil. Use of other oil may not provide proper lubrication of drive-end components and may result in damage to the crankcase of the pump.

1. Fill pump crankcase to specific capacity indicated on data sheet or service manual prior to startup.
2. Cat Pumps premium custom-blend oil is available worldwide in 21-ounce bottles, (single and 12-pack cases), 2.5 gallon jugs (single and 2-pack) or 30 gallon drums. **Use of other oils may void the warranty.**

### B. PUMP ROTATION DIRECTION HAZARD

Do not rotate pump crankshaft in reverse direction. Rotation of pump crankshaft in reverse direction may not provide proper lubrication and may result in damage to the drive-end components.

1. Forward rotation is the top of the crankshaft turning towards the manifold head of the pump.
2. Ensure oil is filled to the center red dot on sight gauge for forward rotation.
3. If reverse rotation is unavoidable, ensure oil is filled to slightly above center red dot on sight gauge.

### C. BELT TENSION HAZARD

Do not operate pump with excessive belt tension. Excessive belt tension may damage the pump's bearings or reduce horsepower.

1. Rotate pump crankshaft before starting to ensure shaft and bearings are moving freely.
2. Ensure pulleys are properly sized.
3. Periodically replace belts to assure full horsepower transmission.
4. Ensure center distance dimensions between pulleys is correct.

### D. BYPASS OPERATION HAZARD

Do not operate the pump in bypass for extended lengths of time. Operating the pump under this condition can quickly cause heat build-up resulting in damage to the pump.

1. Route bypass line to supply reservoir to dissipate heated bypass liquid into a large reservoir of cool water to reduce excessive temperature build-up.
2. Route bypass line to inlet of pump using a thermo valve in the bypass line or auto shut-off assembly that will sense temperature rise and either bypass or shut down system before damage occurs.

### E. DRY OPERATION HAZARD

Do not operate the pump without water or liquid. Operating pump under these conditions could result in damage to the pump.

1. Open all valves on inlet side of pump before starting operation to prevent starving the pump.
2. Do not exceed inlet suction pressure limit specified in pump data sheet.
3. Ensure inlet feed exceeds the maximum flow being delivered by the pump.
4. Ensure all fittings, pipes and hoses are properly-sized for the pump to avoid restricted flow.
5. Review and implement all other recommendations appropriate for your system from the *Inlet Condition Check-List*.

# Seal & Valve Kits

## SERVICE INTERVALS

Typically, plunger pumps require only a very basic standard maintenance procedure of regular oil changes and seal and valve replacement. Seal and valve life are extremely dependent upon the type of pumped liquid, temperature, inlet conditions, system protective devices, filtration, duty-cycle and maintenance-cycle. Most system failures are not due to the pump, but fail because of other system components.

The Preventative Maintenance Check-List (on page 22) provides a summary of the various system maintenance concerns for all high-pressure systems.

The seals on our pumps, operating under normal conditions, will perform for a minimum of 1500 hours, with most lasting much longer. The valves typically perform for 3000 hours, with many lasting much longer. Cat Pumps always recommends replacing these items as a kit since components usually wear at about the same rate.

## SEAL KITS

2560, 2560BH: PN 76853 | Qty 1



2565, 2565BH: PN 76854 | Qty 1



## VALVE KIT

PN 31292 | Qty 1



# Seal & Valve Kit Pump Diagram

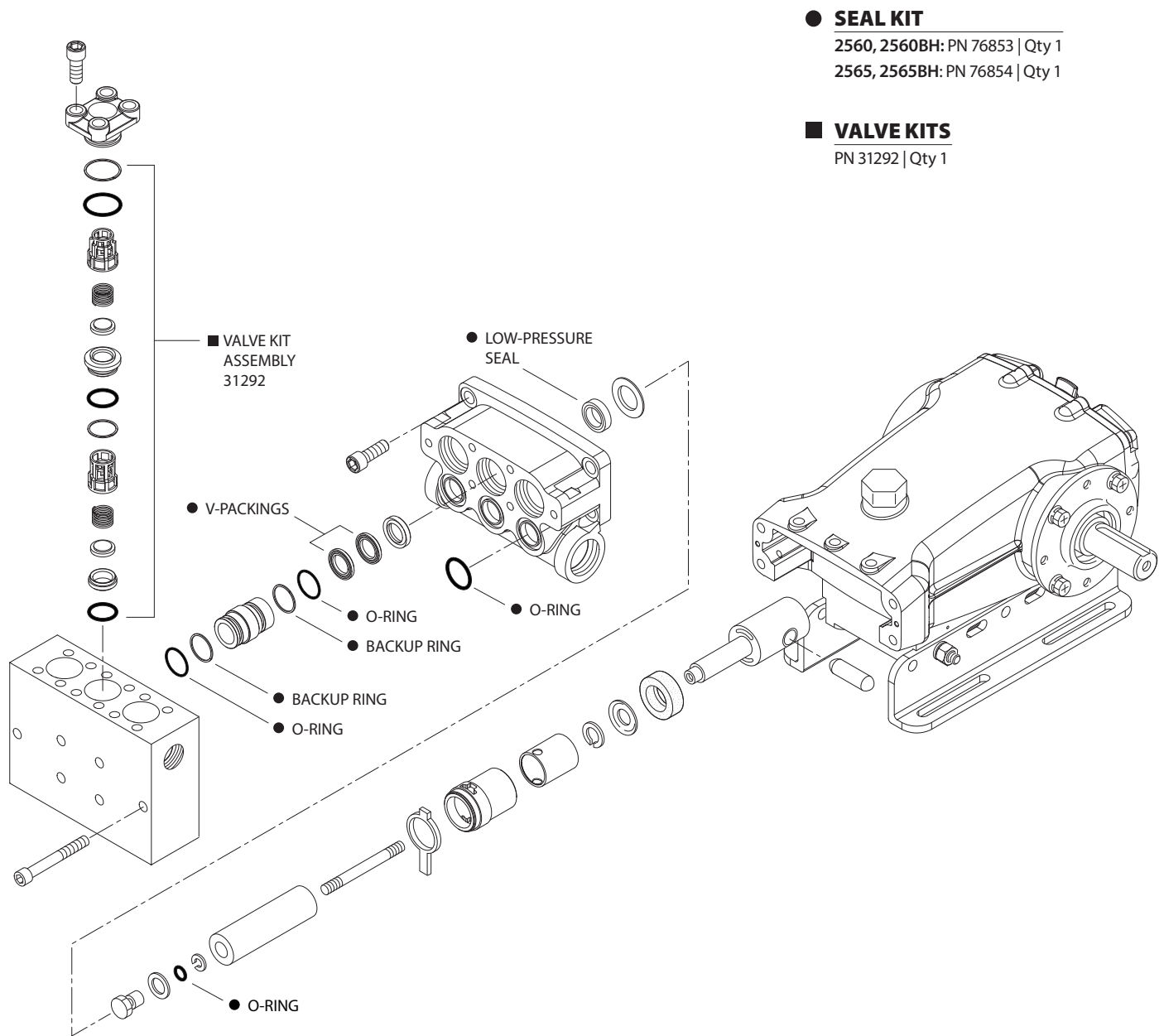

## Tools Needed

- |                                    |                             |
|------------------------------------|-----------------------------|
| 1. 10 mm Hex Socket                | 6. 14 mm Combination Wrench |
| 2. Small Flat Tip Screwdriver      | 7. Rubber Mallet            |
| 3. 2 x Large Flat Tip Screwdrivers | 8. Oil Bubble Gauge Tool    |
| 4. Pick                            | 9. Lubricating Oil          |
| 5. Reverse Pliers (PN 30696)       | 10. Liquid Thread Sealant   |



# Servicing the Seals

## MANIFOLD AND SEAL REMOVAL

**NOTE:** One (1) seal kit is required to repair the pump (see data sheet PN 99DAT090).

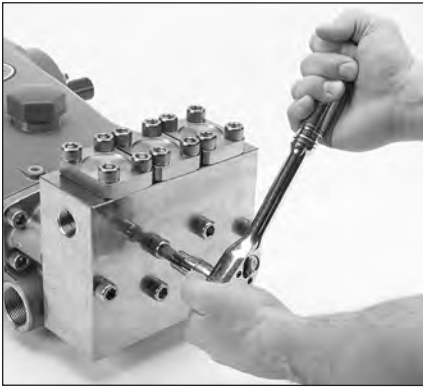

1.01 Use a 10 mm hex socket to remove the six (6) hex socket head screws (HSH) from the discharge manifold.

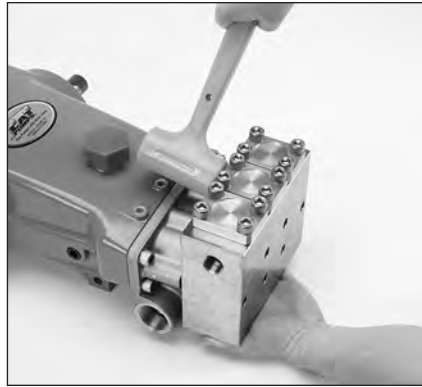

1.02 Support the manifold from underneath. Using a rubber mallet, tap the manifold to separate from the inlet manifold and remove completely.

**NOTICE:** The discharge manifold is very heavy so use caution. Be sure to properly support the bottom of the manifold to avoid injury.



1.03 Place the discharge manifold on a flat surface with the V-packing spacer bores facing up.

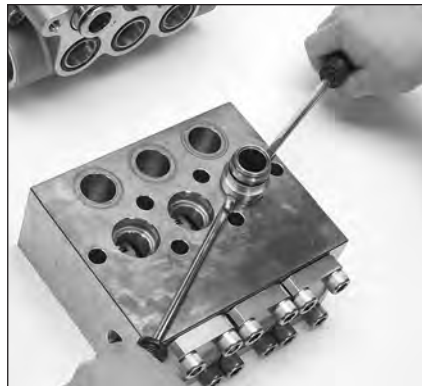

1.04 If the V-packing spacers remain in the discharge manifold, use two (2) flat tip screwdrivers on opposite sides to pry the spacers loose from the manifold and remove.



1.05 If the V-packing spacers remain in the inlet manifold, remove by inserting two screwdrivers on opposite sides to pry out of chamber.



1.06 Inspect O-ring and backup ring for damage.



1.07 Using a pick, remove both sets of O-rings and backup rings from V-packing spacers.



1.08 Use a small pick to remove inlet manifold O-rings.



# Servicing the Seals

## MANIFOLD AND SEAL REMOVAL



1.09 Use a 10 mm hex socket to remove the four (4) HSH screws from the inlet manifold.

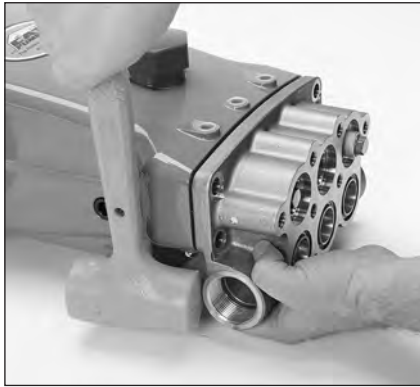

1.10 Using a rubber mallet, tap the manifold to create a separation between the crankcase and the manifold.

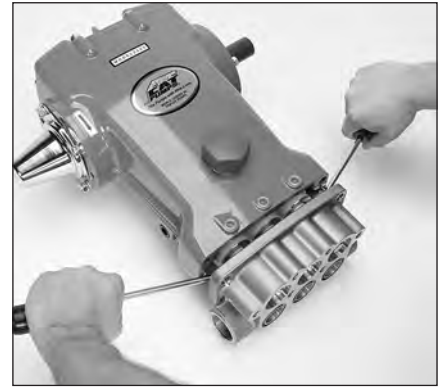

1.11 Insert two (2) flat tip screwdrivers on opposite sides to pry the manifold away from the crankcase.



1.12 Remove inlet manifold by hand and place on a flat surface with V-packing spacer bores facing up.



1.13 Use a flat tip screwdriver to pry the first V-packing upward and remove.

**NOTICE:** Be careful not to score the inside of the manifold.



1.14 Repeat for the second V-packing, inspect both for wear or damage.



1.15 Remove the female adapter and inspect for wear or damage.



1.16 Inspect the manifold bore to ensure sealing surface is smooth and free from corrosion.

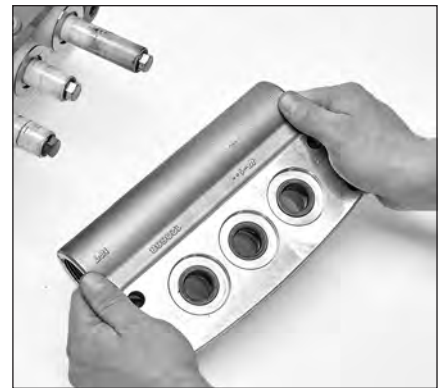

1.17 Flip the inlet manifold over so low-pressure seals are facing upwards.

# Servicing the Seals

## MANIFOLD AND SEAL REMOVAL



- 1.18 Use a flat tip screwdriver to pry the low-pressure seal upward and remove.

**NOTICE:** Be careful not to score the inside of the manifold.



- 1.19 Inspect the inside diameter of the low-pressure seals for wear or damage.

# Servicing the Seals

## PLUNGER REMOVAL

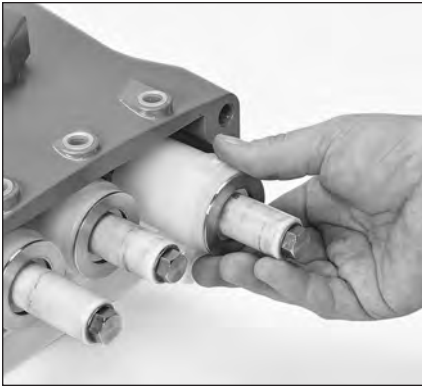

1.20 Remove seal retainers from crankcase housing.



1.21 Remove low-pressure seal washer.



1.22 Seal retainer can be separated to remove and inspect the wicks. Replace as needed (wicks not included in the seal kit).



1.23 Using a 14 mm combination wrench, loosen the plunger retainer.



1.24 Before completely removing the plunger retainer, stop and push the plunger towards the drive end to break loose from the retainer. Remove the plunger and retainer.



1.25 Remove the plunger retainer from the plunger and inspect the O-ring and backup ring for damage.



1.26 Using a pick, remove the plunger retainer O-ring from plunger retainer.



1.27 Inspect ceramic plunger for cracks and scoring to the surface. Clean with a wire-wheel brush if necessary.

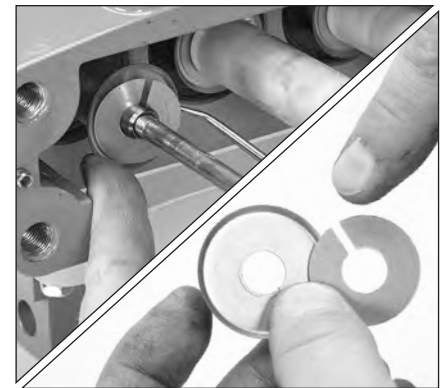

1.28 Use a pick to remove keyhole washer and barrier slinger located behind the plunger. Inspect for damage.

# Servicing the Seals

## PLUNGER REASSEMBLY

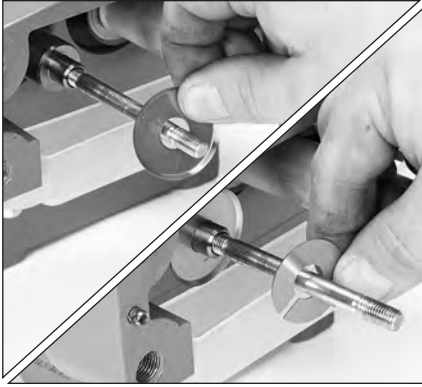

- 1.29 Install barrier slinger with dish side facing away from crankcase.
- 1.30 Install keyhole washer. The slot can face any direction.



- 1.31 Replace plunger retainer O-ring with new one from seal kit and apply a lubricant to outside surface.



- 1.32 Look for stepped side of plunger. This side goes towards the pump crankcase.



- 1.33 Insert plunger retainer with O-ring and backup ring into non-stepped side of plunger.



- 1.34 Place a drop of Loctite® 242® on the threaded end of the plunger rod.

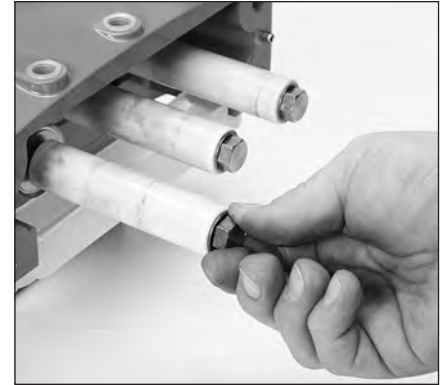

- 1.35 Thread plunger assembly onto plunger rod by hand.



- 1.36 Using a 14 mm combination wrench, torque to 108 in-lbs, 7.5 ft-lbs or 10 Nm.

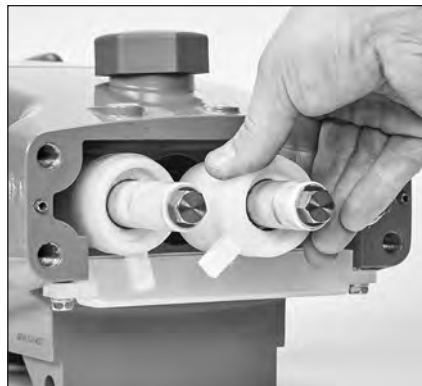

- 1.37 Install seal retainer with wick tab facing down towards the oil pan.

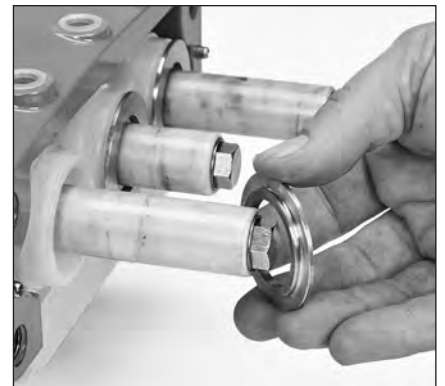

- 1.38 Press low-pressure seal washer onto seal retainer.

Loctite and 242 are registered trademarks of the Henkel Corporation.

# Servicing the Seals

## SEAL INSTALLATION

**NOTICE:** Examine manifolds, and male and female adapters for grooves, pitting or wear. Replace as needed.



1.39 Apply a lubricant to the outside surface of the low-pressure seals.



1.40 One side of the low-pressure seal has a groove. Install groove side facing down and press into place.



1.41 Flip inlet manifold over so that valve spacer bores are facing up.



1.42 The female adapter has a flat side and a grooved side. Install with the groove side facing up.



1.43 Install the first V-packing with the groove side facing up.



1.44 Install the second V-packing with the groove side also facing up.



1.45 Install backup rings, then O-rings onto the V-packing spacers.

**NOTICE:** Backup rings go on the inside of the grooves, and O-rings on the outside.



1.46 Apply a lubricant to the V-packing spacer O-rings.



1.47 The V-packing spacer has two distinct steps. Press the longer side with the groove into the inlet manifold.

Loctite and 242 are registered trademarks of the Henkel Corporation.

# Servicing the Seals

## MANIFOLD REASSEMBLY



1.48 Rotate crankshaft so outside two plungers are even at furthest distance from crankcase.

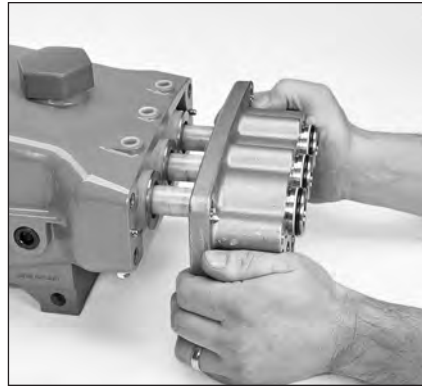

1.49 Install inlet manifold by hand, ensuring even alignment. Press into place.



1.50 Place a drop of Loctite® 242® on the threaded end of the four (4) HSH screws and install by hand.



1.51 Using a 10 mm hex socket, tighten HSH screws. Torque to 355 in-lbs, 30 ft-lbs, or 40 Nm.



1.52 Replace inlet manifold O-rings.

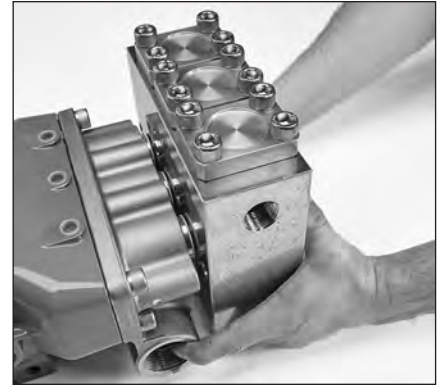

1.53 Lift the discharge manifold into place against the inlet manifold and V-packing spacers and press into place.

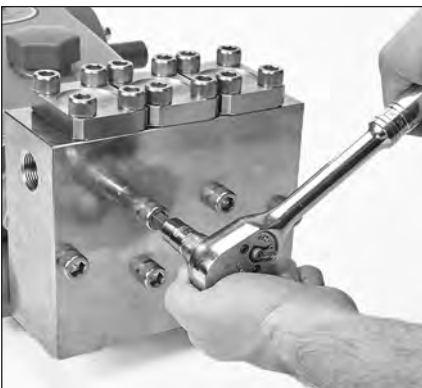

1.54 Install six (6) HSH screws by hand. Using a 10 MM hex socket, tighten screws using appropriate cross-pattern for even alignment. Torque to 355 in-lbs, 30 ft-lbs, or 40 Nm.

### TORQUE SEQUENCE

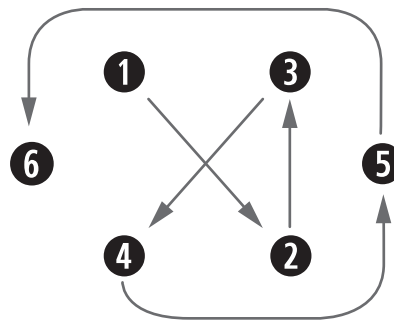

Loctite and 242 are registered trademarks of the Henkel Corporation.

# Servicing the Valves

## VALVE REMOVAL

**NOTE:** One (1) valve kit is required to repair the pump (see data sheet PN 99DAT090).

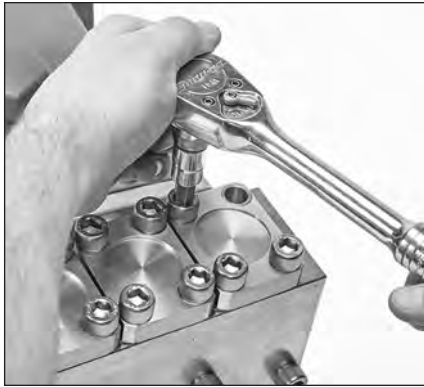

2.01 Use a 10 mm hex socket to remove the four (4) HSH screws from the valve plug.

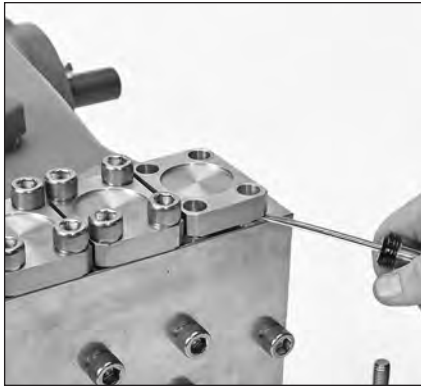

2.02 Using a small flat tip screwdriver, tap between the notched corner of the valve plug and the manifold to create a gap and pry upwards.



2.03 Remove the valve plug by hand.



2.04 Inspect valve plug O-ring and backup ring for cuts, nicks or damage.



2.05 Using a pick, remove O-ring and backup ring from valve plug.



2.06 Use a reverse pliers to grasp the center of the valve spring retainer. Twist while pulling away from manifold to remove valve assembly.



2.07 The valve seat O-ring may remain in the manifold. Use a pick or small flat tip screwdriver to remove O-ring.

**NOTICE:** Valve assembly can be disassembled for inspection and servicing, then reassembled. If replacing the complete valve kit assembly, skip to Valve Installation 2.37.

# Servicing the Valves

## VALVE DISASSEMBLY



2.08 Insert a flat tip screwdriver through discharge spring retainer just above discharge valve. Twist to create a small gap between discharge spring retainer and discharge valve seat.



2.09 Remove discharge spring retainer by hand.

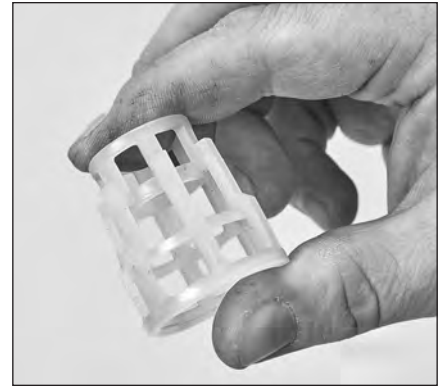

2.10 Inspect discharge valve spring retainer for cracks, excessive wear or damage.



2.11 Inspect spring for proper tension or any damage.



2.12 Inspect tapered surface of discharge valve for wear, pitting or damage.



2.13 Remove discharge valve seat by hand.



2.14 Inspect tapered surface of discharge valve seat for wear, pitting or damage.

**NOTICE:** Pitting on the valve or valve seat is an indication of cavitation.



2.15 Inspect discharge valve seat O-ring and backup ring for cuts, nicks or damage.

2.16 Using a pick, remove O-ring and backup ring from discharge valve seat.



2.17 Insert a flat tip screwdriver through inlet spring retainer just above inlet valve. Twist to create a small gap between inlet spring retainer and inlet valve seat.



# Servicing the Valves

## VALVE DISASSEMBLY



2.18 Remove inlet spring retainer by hand.

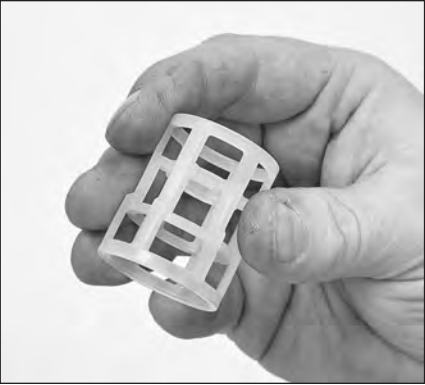

2.19 Inspect inlet valve spring retainer for cracks, excessive wear or damage.



2.20 Inspect spring for proper tension or any damage.



2.21 Inspect tapered surface of inlet valve for wear, pitting or damage.



2.22 Inspect tapered surface of inlet valve seat for wear, pitting or damage.

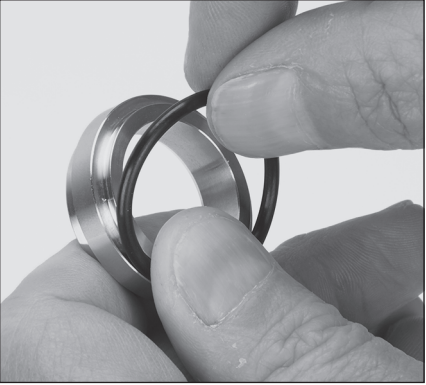

2.23 Inspect inlet valve seat O-ring for cuts, nicks or damage and remove.

# Servicing the Valves

## VALVE REASSEMBLY



2.24 Replace inlet valve O-ring.



2.25 Hold inlet valve seat with tapered surface facing up.



2.26 Place inlet valve onto inlet valve seat with tapered surface facing down.



2.27 Place spring onto stepped side of inlet valve.

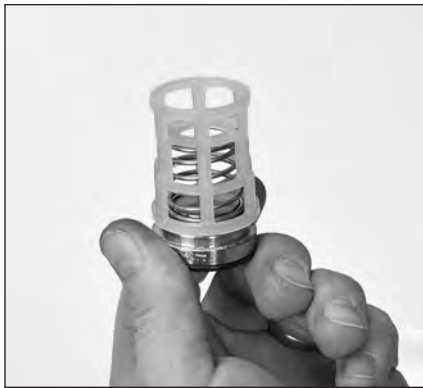

2.28 Place inlet valve spring retainer onto inlet valve seat.

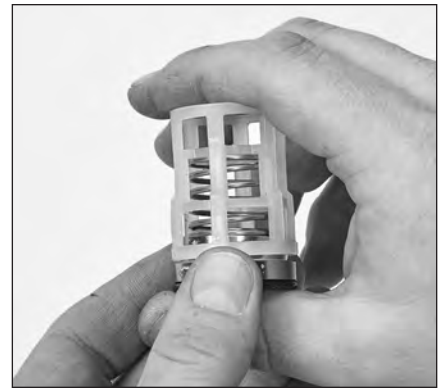

2.29 Push assembly together until it snaps into place.



2.30 Replace discharge valve backup ring, then O-ring onto discharge valve seat.



2.31 Install discharge valve seat onto inlet spring retainer and push assembly together until it snaps into place.



2.32 Place discharge valve onto discharge valve seat with tapered surface facing down.

# Servicing the Valves

## VALVE REASSEMBLY



2.33 Place spring onto stepped side of discharge valve.

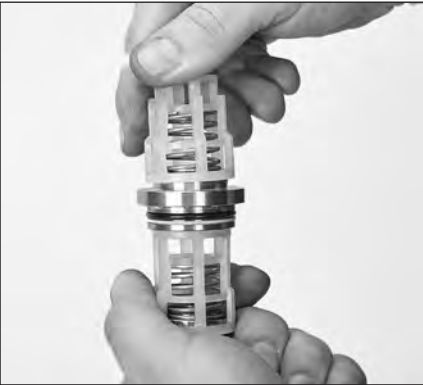

2.34 Place discharge valve spring retainer onto discharge valve seat.



2.35 Push assembly together until it snaps into place.



2.36 Apply a lubricant to the outside surface of the inlet valve seat O-ring.

# Servicing the Valves

## VALVE INSTALLATION



2.37 Apply a lubricant to the outside surface of the discharge valve seat O-ring.

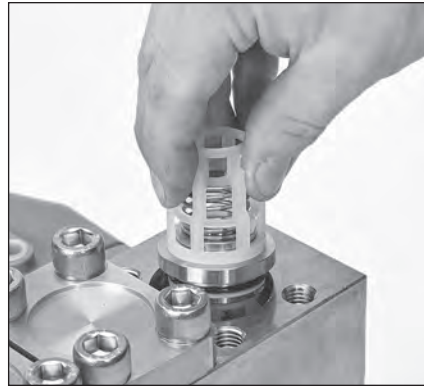

2.38 Insert valve assembly into manifold and press into place.

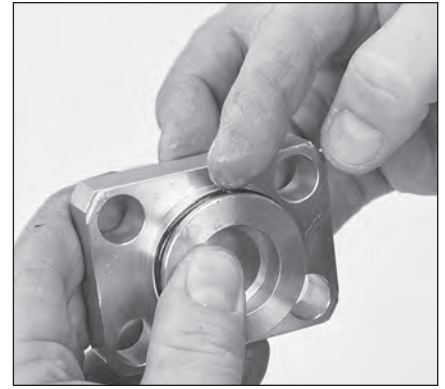

2.39 Install valve plug backup ring, then O-ring, and apply a lubricant to outside surface.

**NOTICE:** Valve plug O-ring faces down when installed in the manifold.

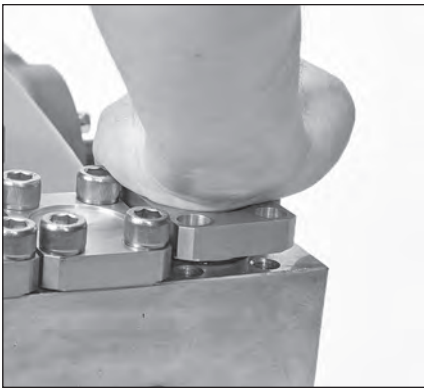

2.40 Install valve plug into manifold and press into place.



2.41 Install four (4) HSH screws by hand.

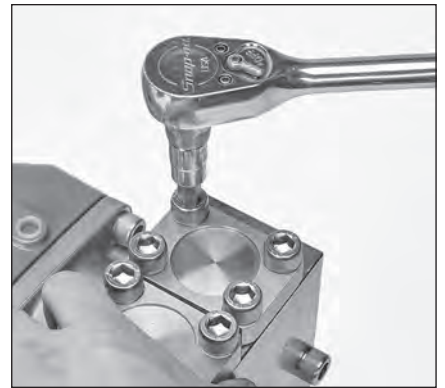

2.42 Using a 10 mm hex socket, tighten HSH screws using appropriate cross-pattern for even alignment. Torque to 355 in-lbs, 30 ft-lbs, or 40 Nm.

## TORQUE SEQUENCE

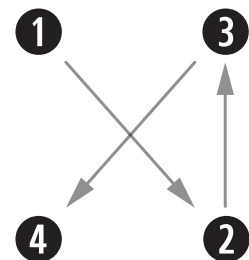

# Crankcase Component Inspection

Inspection of the crankcase for leaks is an essential step in the preventive maintenance of a pump. Worn seals and O-rings not only can create a mess with leaking oil, but can lead to premature parts wear and damage due to low crankcase oil level.

Crankcase oil that appears cloudy or milky in the Oil Bubble Gauge indicates the presence of water in the crankcase. A water/oil mix does not provide enough lubrication to the components in the drive end and will cause damage. This damage can occur on the plunger rods or the crankshaft and connecting rods. Also, without a layer of oil on the drive end components, oxidation and rust will form on the bearings and crankshaft. If contamination is suspected, inspect and replace the seals in the pump manifold, then clean out the inside of the crankcase and change the oil.

Spot-check the following areas for signs of leaks and contact Cat Pumps or a local distributor for servicing crankcase if needed.

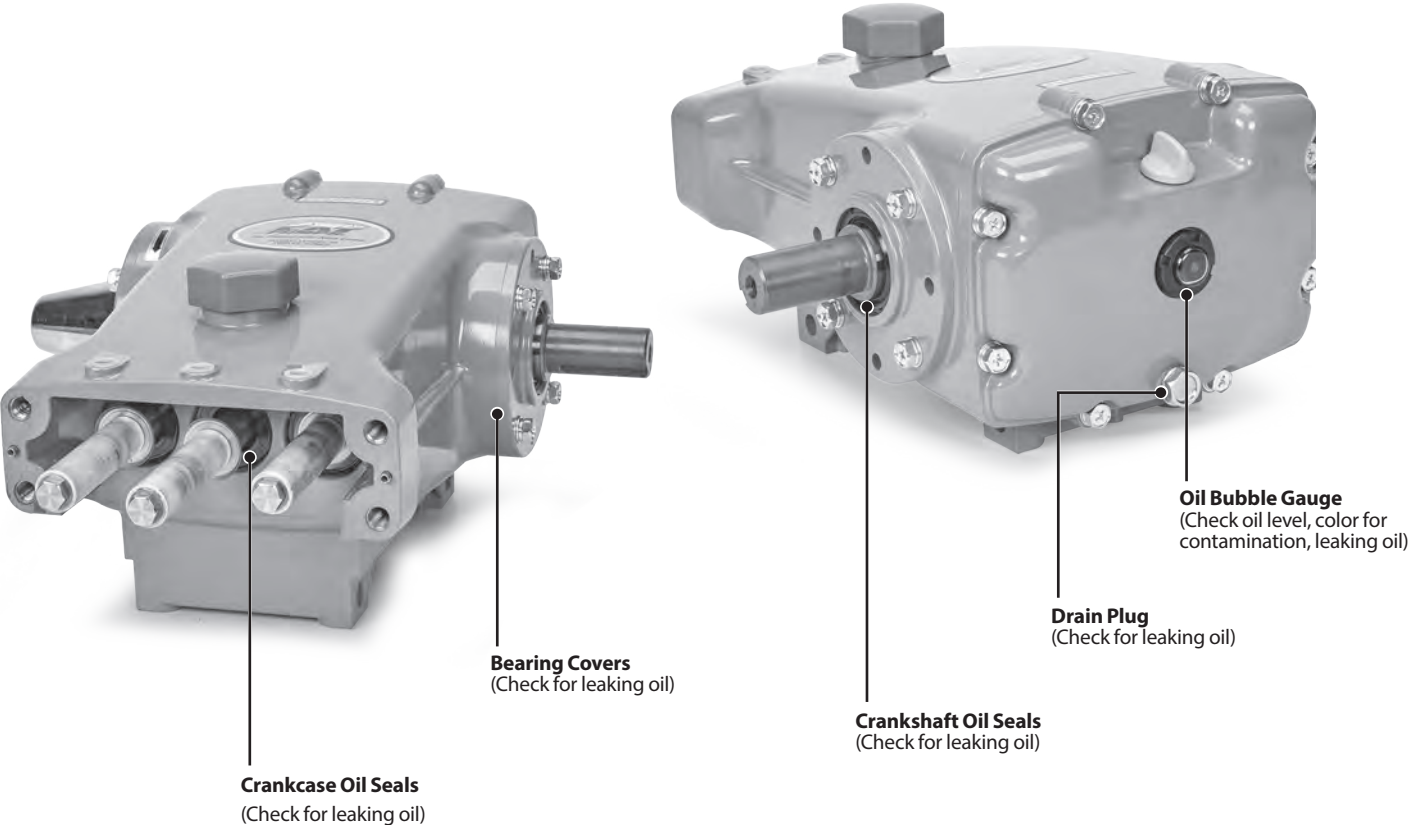

# Reference Information

## PREVENTIVE MAINTENANCE SCHEDULE

Many application factors determine proper pump maintenance intervals. Variation in duty cycle, operating performance, fluid temperature, fluid type, inlet conditions and application environment can affect maintenance schedules. Every application should be evaluated and serviced based on its own requirements. The following checklist is intended as a reference guide only.

CHECK	DAILY	WEEKLY	50 HRS.	500 HRS.	1500 HRS.	3000 HRS.
Filters	• or •					
Oil Level/Quality	• or •		①	①		
Water Leaks	• or •					
Oil Leaks	•					
Plumbing		•				
Belts, Pulley		•				
Accessories					•	
Seals					②	
Valves						③

Water leaks or loss of system performance can be an indicator of seal wear. Seal wear has many causes, including contaminated liquid or high-temperature/run dry operation. If the low-pressure seals show wear, the high-pressure seals most likely are in a similar condition. It is a good practice to replace both low and high-pressure seals and inspect plungers when leaks are present.

- ① Cat Pumps recommends using our custom-blend premium grade hydraulic oil formulated to meet Cat Pumps specifications. For best results, perform an initial oil change after the first 50 hours of operation and every 500 hours thereafter.
- ② Every system operates under different conditions. Past performance and maintenance history are the best indicators of future performance. If system performance degrades or changes, check seals and valves immediately. Service as required to restore system performance. Depending upon operating conditions, maintenance intervals for seals kits range between 1,500 and 8,000 hours.
- ③ Pump valves typically require changing every other seal change. If system performance degrades or changes, check valves immediately. Depending upon operating conditions, maintenance intervals for valve kits range between 3,000 and 16,000 hours.

Cat Pumps custom blend crankcase oil is exclusively designed, tested and proven to maximize the life of your pump. This special formulated premium-grade, petroleum-based, ISO 68 hydraulic oil contains the most advanced additive package to protect against wear, oxidation, rust and corrosion.

Cat Pumps premium custom-blend oil is available worldwide in 21-ounce bottles, (single and 12-pack cases), 2.5 gallon jugs (single and 2-pack) or 30 gallon drums. **Use of other oils may void the warranty.**



# Reference Information

## TORQUE CHART

PUMP ITEM	THREAD	TOOL SIZE	TOOL PART NUMBER	TORQUE		
				IN-LBS	FT-LBS	Nm
Plunger Retainers	M7	M14 Hex	—	108	7.5	10.0
Inlet Manifold Screws	M12	M10 Allen	—	355	30	40.0
Discharge Manifold Screws	M12	M10 Allen	—	355	30	40.0
Valve Plug Cover Screws	M12	M10 Allen	—	355	30	40.0
Rear Cover Screws	M8	M13 Hex	—	115	9.58	13.0
Bearing Cover Screws	M8	M13 Hex	—	115	9.58	13.0
Connecting Rod Screws	M8	M13 Hex	—	130	10.8	15.0
Bubble Oil Gauge	M28	Oil Gauge Tool	44050	45	3.8	5.0

## DISCHARGE MANIFOLD TORQUE SEQUENCE

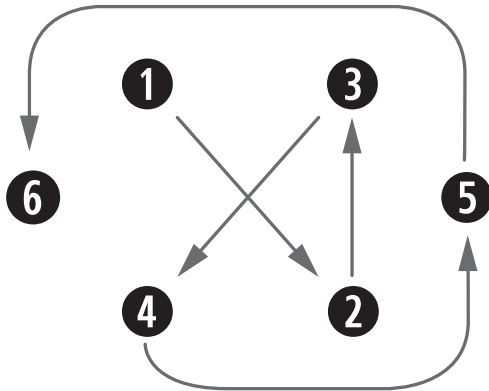

## TECHNICAL BULLETIN REFERENCE CHART

NO.	SUBJECT	MODELS
002	Inlet Pressure vs. Liquid Temperature	All Models
024	Lubrication of Low-Pressure Seals	All Models
034	Servicing Crankcase Section – Ball Bearing Models	3FR, 4FR, 5FR, 10FR, 25FR, 3CP, 5CP, 3PFR, 5PFR, 25PFR, 28PFR
036	Identifying Your Pump	All Models
043	Servicing the Low and High-Pressure Seals	All Plunger Models
074	Torque Chart	All Models
083	Winterizing a Pump	All Models
134	Piston and Plunger Pump Crankcase Capacities	Piston and Plunger Pumps

## VALVE PLUG COVER TORQUE SEQUENCE

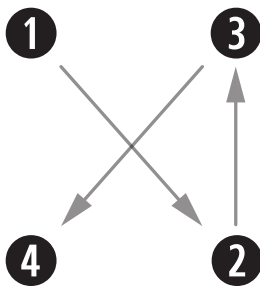

# Diagnosis and Maintenance

This service manual is designed to assist you with the disassembly and reassembly of your pump. The following guide will assist in determining the cause and remedy to various operating conditions. You can also review our **FAQ** or **SERVICE & TRAINING** sections on our **WEB SITE** for more facts or contact Cat Pumps directly.

PROBLEM	PROBABLE CAUSE	SOLUTION
<b>Low pressure</b>	<ul style="list-style-type: none"> <li>• Worn nozzle.</li> <li>• Air leak in inlet plumbing.</li> <li>• Pressure gauge inoperative or not registering accurately.</li> <li>• Relief valve stuck, partially plugged or improperly adjusted.</li> <li>• Inlet suction strainer (filter) clogged or improperly sized.</li> <li>• Abrasives in pumped liquid.</li> <li>• Leaky discharge hose.</li> <li>• Inadequate liquid supply.</li> <li>• Severe cavitation.</li> <li>• Worn seals.</li> <li>• Worn or dirty inlet/discharge valves.</li> </ul>	<ul style="list-style-type: none"> <li>• Replace with proper size nozzle.</li> <li>• Tighten fittings and hoses. Use PTFE liquid or tape.</li> <li>• Check with new gauge. Replace worn or damaged gauge.</li> <li>• Clean/adjust relief valve. Replace worn seats/valves and O-rings.</li> <li>• Clean filter. Use adequate size filter. Check more frequently.</li> <li>• Install proper filter.</li> <li>• Replace discharge hose with proper rating for system.</li> <li>• Pressurize inlet.</li> <li>• Check inlet conditions.</li> <li>• Install new seal kit. Increase frequency of service.</li> <li>• Clean inlet/discharge valves or install new valve kit.</li> </ul>
<b>Pulsation</b>	<ul style="list-style-type: none"> <li>• Foreign material trapped in inlet/discharge valves.</li> </ul>	<ul style="list-style-type: none"> <li>• Clean inlet/discharge valves or install new valve kit.</li> </ul>
<b>Water leak</b>		
<ul style="list-style-type: none"> <li>• Under the manifold</li> <li>• Into the crankcase</li> </ul>	<ul style="list-style-type: none"> <li>• Worn high-pressure or low-pressure seals.</li> <li>• Humid air condensing into water inside the crankcase.</li> <li>• Excessive wear to high-pressure or low-pressure seals.</li> </ul>	<ul style="list-style-type: none"> <li>• Install new seal kit. Increase frequency of service.</li> <li>• Install new oil cap protector. Change oil every 3 months or 500 hours.</li> <li>• Install new seal kit. Increase frequency of service.</li> </ul>
<b>Knocking noise</b>		
<ul style="list-style-type: none"> <li>• Inlet supply</li> <li>• Bearing</li> </ul>	<ul style="list-style-type: none"> <li>• Inadequate inlet liquid supply.</li> <li>• Broken or worn bearing.</li> </ul>	<ul style="list-style-type: none"> <li>• Check liquid supply. Increase line size or pressurize.</li> <li>• Replace bearing.</li> </ul>
<b>Oil leak</b>		
<ul style="list-style-type: none"> <li>• Crankcase oil seal</li> <li>• Crankshaft oil seal and O-ring</li> <li>• Drain plug</li> <li>• Bubble gauge</li> <li>• Bearing cover</li> <li>• Filler cap</li> </ul>	<ul style="list-style-type: none"> <li>• Worn crankcase oil seal.</li> <li>• Worn crankshaft oil seal or O-ring on bearing cover.</li> <li>• Loose drain plug or worn drain plug O-ring.</li> <li>• Loose bubble gauge or worn bubble gauge gasket.</li> <li>• Loose bearing cover or worn bearing cover O-ring.</li> <li>• Loose filler cap or excessive oil in crankcase.</li> </ul>	<ul style="list-style-type: none"> <li>• Replace crankcase oil seal.</li> <li>• Remove bearing cover and replace O-ring and/or oil seal.</li> <li>• Tighten drain plug or replace O-ring.</li> <li>• Tighten bubble gauge or replace gasket.</li> <li>• Tighten bearing cover or replace O-ring.</li> <li>• Tighten filler cap. Fill crankcase to specified capacity.</li> </ul>
<b>Pump runs extremely rough</b>		
<ul style="list-style-type: none"> <li>• Inlet conditions</li> <li>• Pump valves</li> <li>• Pump seals</li> </ul>	<ul style="list-style-type: none"> <li>• Restricted inlet or air entering the inlet plumbing</li> <li>• Stuck inlet/discharge valves.</li> <li>• Leaking high-pressure or low-pressure seals.</li> </ul>	<ul style="list-style-type: none"> <li>• Correct inlet size plumbing. Check for air tight seal.</li> <li>• Clean out foreign material or install new valve kit.</li> <li>• Install new seal kit. Increase frequency of service.</li> </ul>
<b>Premature seal failure</b>		
	<ul style="list-style-type: none"> <li>• Scored plunger.</li> <li>• Over pressure to inlet manifold.</li> <li>• Abrasive material in the liquid being pumped.</li> <li>• Excessive pressure and/or temperature of pumped liquid.</li> <li>• Running pump dry.</li> <li>• Starving pump of adequate liquid.</li> <li>• Eroded manifold.</li> </ul>	<ul style="list-style-type: none"> <li>• Replace plunger.</li> <li>• Reduce inlet pressure per specifications.</li> <li>• Install proper filtration at pump inlet and clean regularly.</li> <li>• Check pressure and inlet liquid temperature.</li> <li>• DO NOT RUN PUMP WITHOUT LIQUID. Fill pump with oil.</li> <li>• Increase hose one size larger than inlet port size or pressurize.</li> <li>• Replace manifold. Check liquid compatibility.</li> </ul>



**CAT PUMPS**  
 1681 - 94TH LANE N.E. MINNEAPOLIS, MN 55449-4324  
 PHONE (763) 780-5440 — FAX (763) 780-2958  
 e-mail: techsupport@catpumps.com  
 www.catpumps.com

For International Inquiries go to [www.catpumps.com](http://www.catpumps.com) and navigate to the "Contact" link.